

1 – Tabulkový procesor

	A	B	C
1	0	=A1+1	
2	=A1+1	=B\$1*\$A2	
3			

1 – HTML

```
<!DOCTYPE html
  PUBLIC "-//W3C//DTD XHTML 1.0 Transitional//EN"
  "http://www.w3.org/TR/xhtml1/DTD/xhtml1-transitional.dtd">
<html>
<head>
  <meta charset="utf-8" />
  <title>Informatika - Gymnázium Nad Alejí</title>
  <link rel="stylesheet" type="text/css" href="alej.css" />
  <script type="text/javascript" language="JavaScript">
    if (0 == 1) {
      alert("Problém");
    }
  </script>
</head>
<body>
<div id="centered">
  <h1>Informatika &mdash; GNA</h1>

  <p>
    Lorem Ipsum Dolor Sit <strong>Amet</strong>.
  </p>

  <address>
    <a href="mailto:vojtech.horky@alej.cz">Vojtěch Horký</a>
  </address>
</div>
</body>

</html>
```

2 – Kaskádové styly (CSS)

HTML

```
<p>
    Sodales torquent mollis
    <strong>vestibulum</strong>
    <a href="http://www.alej.cz">molestie</a>.
</p>
<p class="note">
    Quisque aliquam nunc ac consectetur vivamus phasellus enim.
</p>
```

CSS

```
P {
    line-height: 180%;
    text-align: justify;
}
STRONG {
    color: #000099;
}
P.note {
    font-style: italic;
}
A:link, A:visited, A:active {
    text-decoration: none;
}
A:hover {
    color: red;
    text-decoration: underline;
}
A:link {
    color: blue;
}
A:visited {
    color: magenta;
}

@media print {
    A {
        color: black;
        text-decoration: underline;
    }
}
```

3 – Databáze a SQL

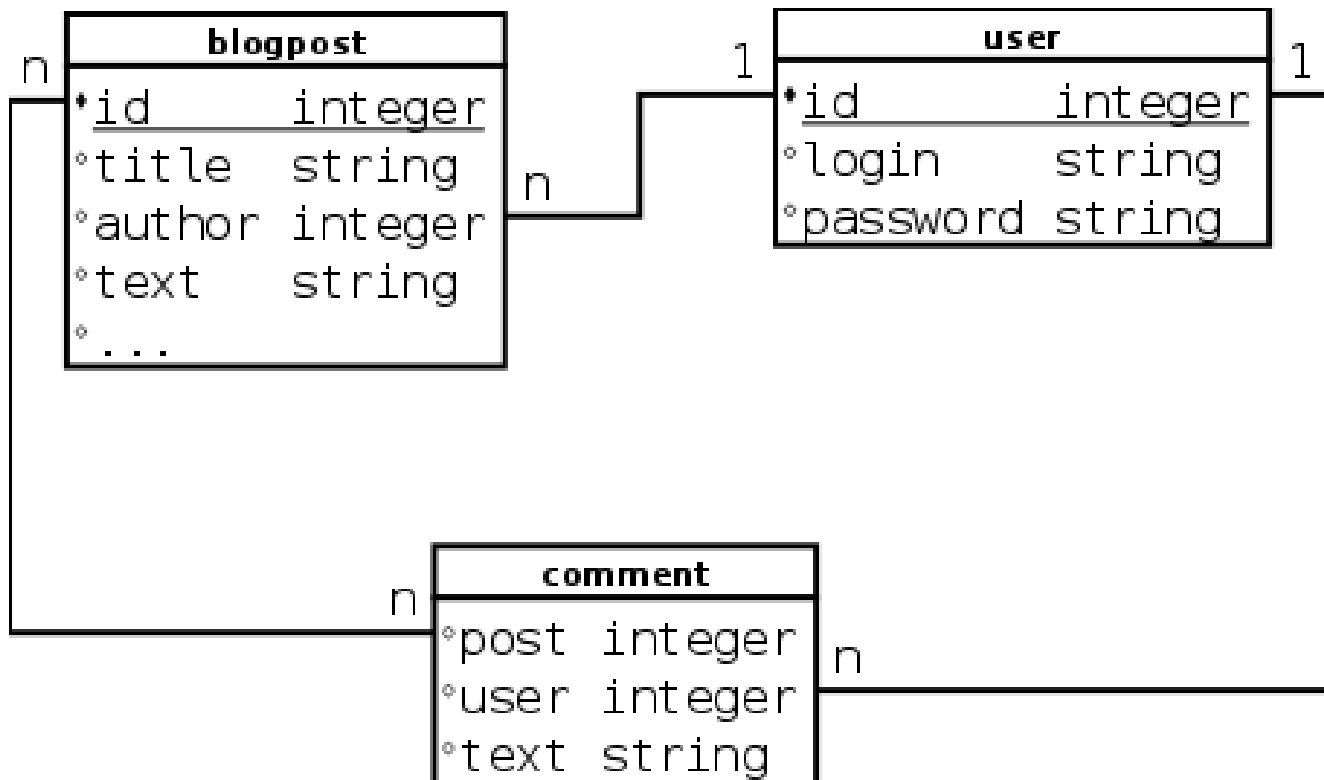

```
SELECT
    title
FROM blogpost
```

```
SELECT
    id, title
FROM blogpost
WHERE author = 11
```

```
SELECT
    text, login
FROM comment JOIN user ON comment.user = user.id
WHERE post = 17
```

4 – Nástroje pro spolupráci při programování

Bug 936906 - Should be able to set devicePixelRatio using JavaScript

Status: UNCONFIRMED	Reported: 2013-11-10 08:49 PST by Liam Wilson
Whiteboard:	Modified: 2013-11-10 13:00 PST (History)
Keywords:	CC List: 3 users (show)
Product: Firefox for Android (show info)	See Also:
Component: Graphics, Panning and Zooming (show other bugs) (show info)	Crash Signature:
Version: Firefox 25	Project Flags:
Platform: ARM Android	Tracking Flags:
Importance: -- normal (vote)	
Target Milestone: ---	
Assigned To: Nobody; OK to take it and work on it	
QA Contact:	
URL:	
Depends on: 737090	
Blocks:	
Show dependency tree / graph	

Attachments

[canvas_banding_example.html](#) (1.09 KB, text/html) no flags [Details](#)
2013-11-10 08:49 PST, Liam Wilson

[Summon comment box](#)

 **Liam Wilson** 2013-11-10 08:49:56 PST [Description](#)

Created [attachment 829877](#) [[details](#)]
canvas_banding_example.html

User Agent: Mozilla/5.0 (X11; Ubuntu; Linux x86_64; rv:25.0) Gecko/20100101 Firefox/25.0 (Beta/Release)
Build ID: 20131028113308

Steps to reproduce:

Created test webpage (see attached). It attempts to create and display a Canvas with a width and height set exactly to the native resolution of the window. It does this using a meta viewport trick (injects some HTML in to the head of the document setting "initial-scale" to `1/window.devicePixelRatio`).

Actual results:

On my Nexus 7 (2012). It created a canvas of 853x469 (landscape). That is the wrong resolution (should be 1280*something). The example above sets the correct resolution in Chrome Android (but it too has banding artifacts suggesting something is still off, see: <http://code.google.com/p/chromium/issues/detail?id=317175>)

Expected results:

Should be able to create a Canvas which is exactly the same resolution as the native window. I've read lots of blog posts about this. They all contain horrible hacks that attempt to fix the problem (as does my example). All of these hacks don't quite work (like doing `canvas.width=screen.width*window.devicePixelRatio`, this cannot work right because `screen.width` is something like `Math.round(realwidth/window.devicePixelRatio)`)

It occurs to me that all these hacks would be unnecessary if I could just go `window.devicePixelRatio=1`

 **Kartikaya Gupta (email:kats@mozilla.com)** 2013-11-10 09:50:07 PST [Comment 1](#)

This is more or less a dupe of [bug-737090](#); the target-densitydpi meta-viewport attribute handled this use case but for reasons that are not really clear it was removed. It would probably be worthwhile to restart the discussion on the W3C mailing lists to bring this back or at least bring back some suitable replacement.

 **Liam Wilson** 2013-11-10 13:00:04 PST [Comment 2](#)

...

4 – Zpracování aritmetického výrazu

$$3 \cdot (1 + 2)$$

$$3 \ 1 \ 2 \ + \ .$$

$$\cdot \ 3 \ + \ 1 \ 2$$

$$E \rightarrow F + E$$

$$E \rightarrow F$$

$$F \rightarrow N * F$$

$$F \rightarrow N$$

$$N \rightarrow \textit{\textsl{číslo}}$$

$$N \rightarrow \textit{\textsl{proměnná}}$$

5 – Vývojové diagramy

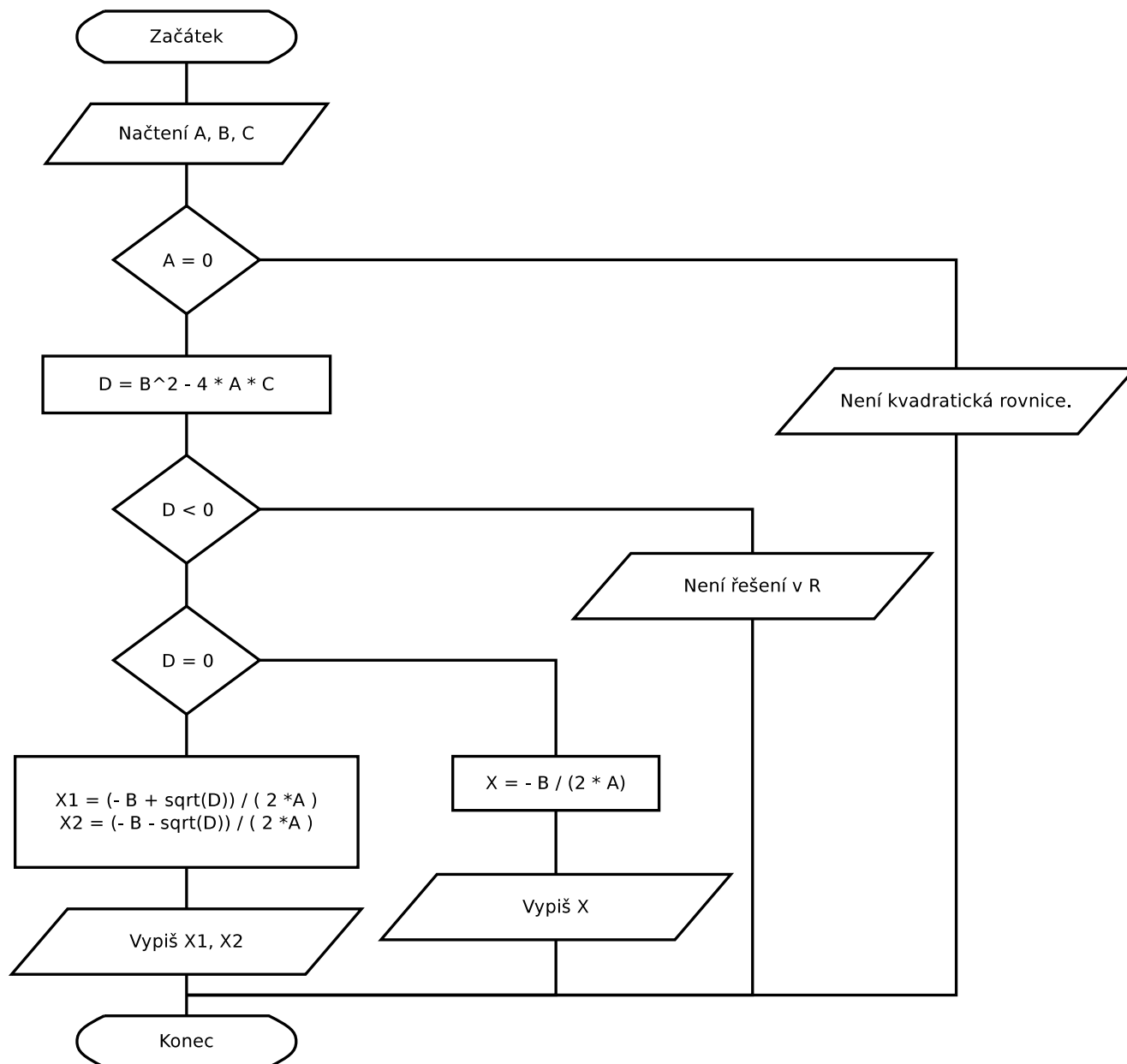

5 – Síťová komunikace

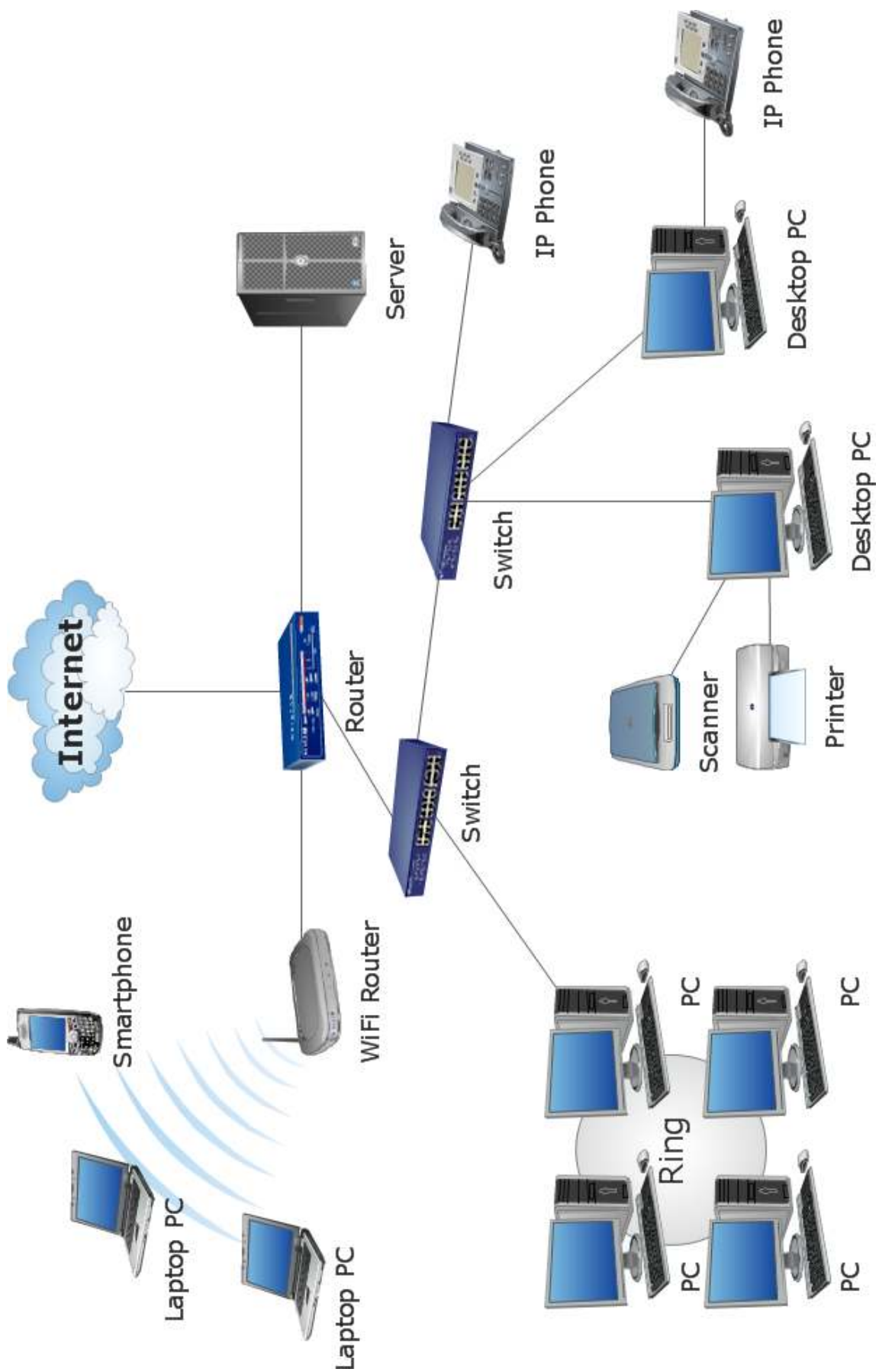

5 – Síťová komunikace

Klient

Server

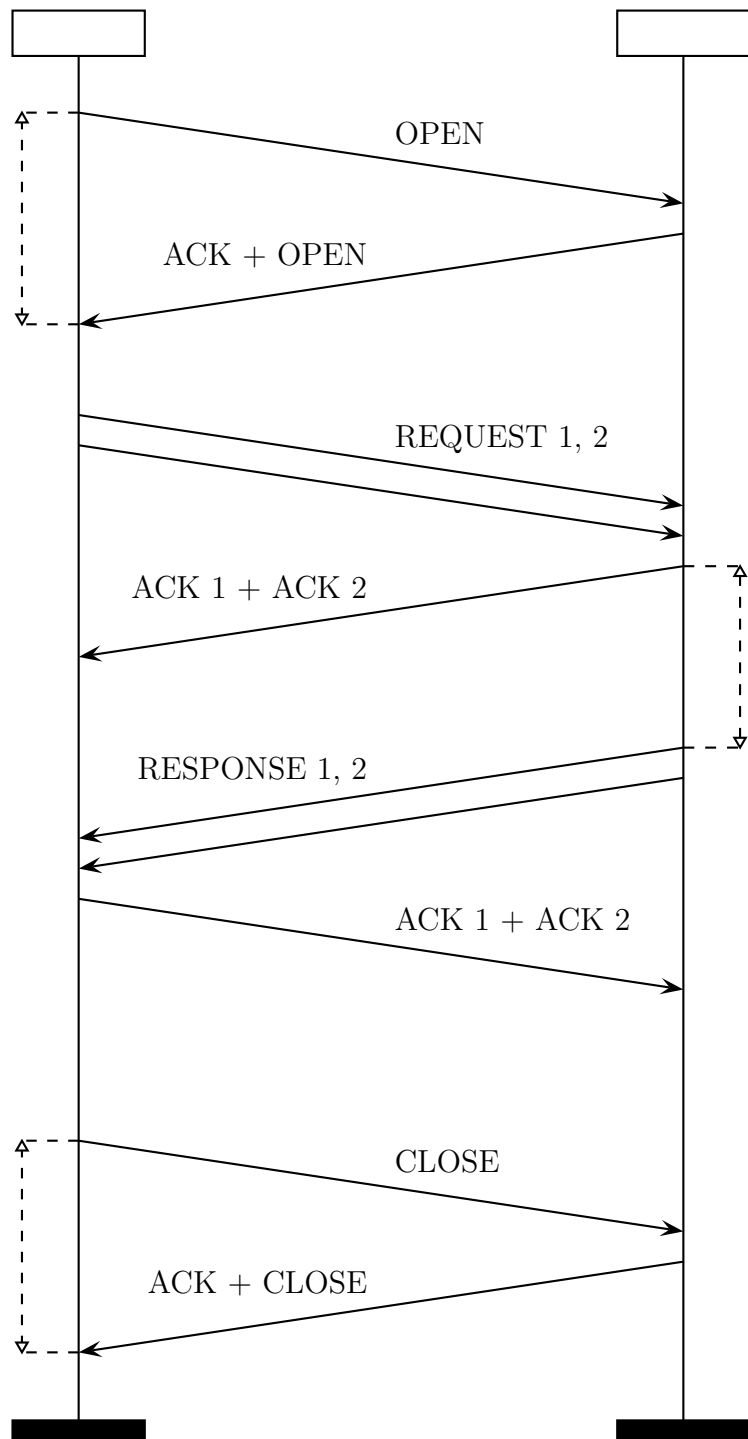

5 – Síťová komunikace

Klient

```
import java.io.*;
import java.net.*;

public class SayHello {
    public static void main(String[] args) throws IOException {
        Socket echoSocket = new Socket("127.0.0.1", 4242);

        PrintWriter out = new PrintWriter(echoSocket.getOutputStream(), true);

        out.println("Hello, World!");

        out.close();
        echoSocket.close();
    }
}
```

Server

```
import java.net.*;
import java.io.*;

public class EchoServer {
    public static void main(String[] args) throws IOException {
        ServerSocket serverSocket = new ServerSocket(4242);

        while (true) {
            Socket clientSocket = serverSocket.accept();

            BufferedReader in = new BufferedReader(
                new InputStreamReader(clientSocket.getInputStream()));

            while (true) {
                String line = in.readLine();
                if (line == null) {
                    break;
                }
                System.out.printf("Client %s said: %s\n", clientSocket, line);
            }

            in.close();
        }
    }
}
```

6 – Adresování na Internetu

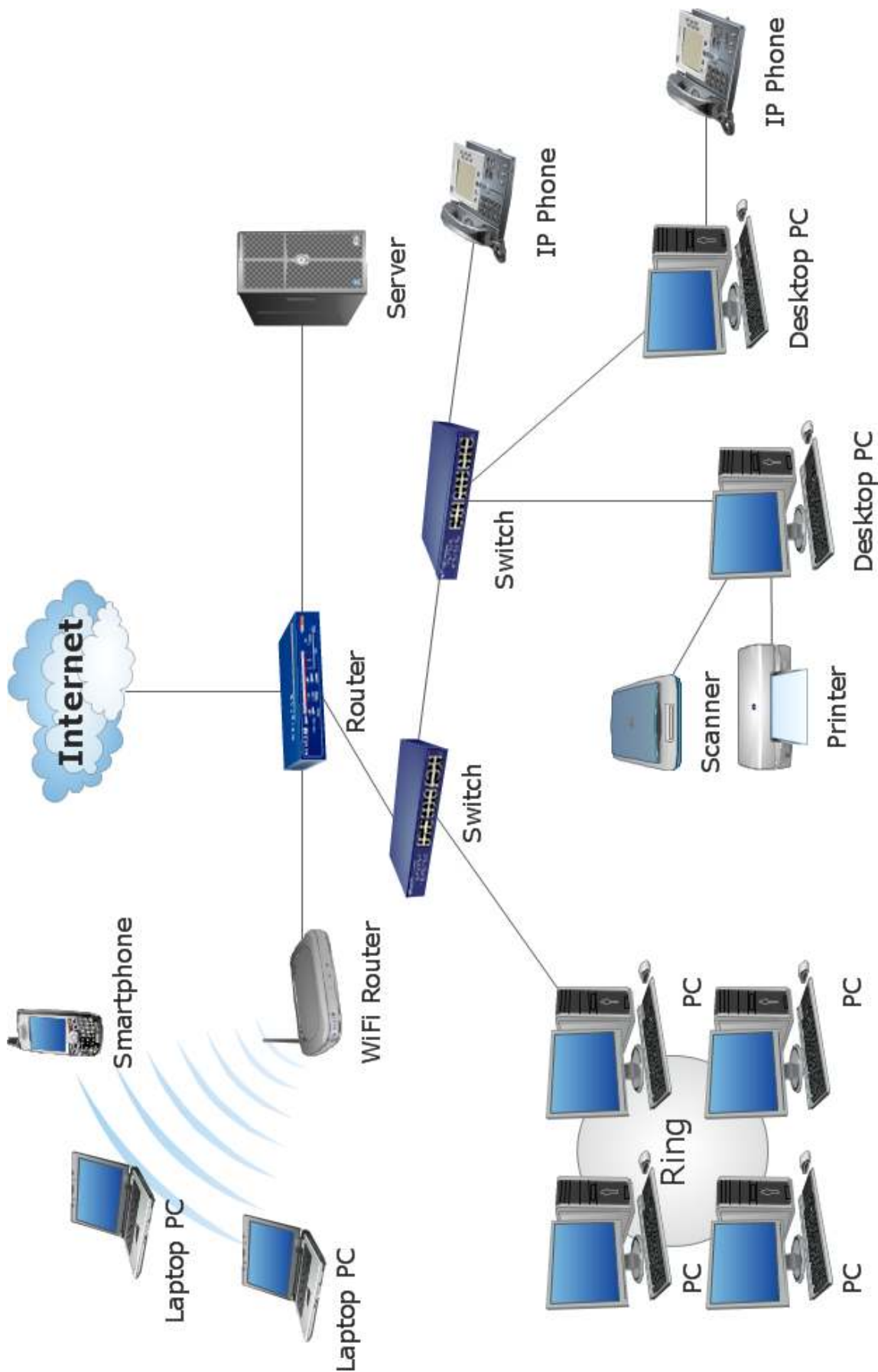

6 – Adresování na Internetu

\$TTL 3600

```
example.org. IN SOA ns1.example.org. admin.example.org. (  
    2014051301 ; Serial  
    10800      ; Refresh  
    3600       ; Retry  
    604800    ; Expire  
    300       ; Negative Response TTL  
)
```

```
IN NS ns1.example.org.
```

```
IN NS ns2.example.org.
```

```
IN MX 10 mail.example.org.
```

```
IN MX 20 mail2.exampe.org.
```

```
ns1    IN A      192.168.1.2
```

```
ns2    IN A      192.168.1.3
```

```
mail   IN A      192.168.1.4
```

```
mail2  IN CNAME ns2
```

```
www    IN A      192.168.1.6
```

```
ftp    IN CNAME  www
```

```
john   IN A      192.168.1.21
```

```
daniel IN A      192.168.1.22
```

7 – Virtualizace a cloud

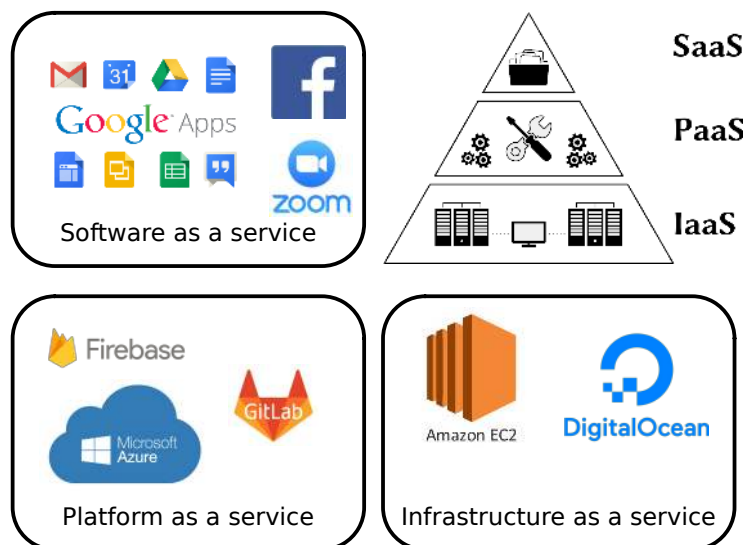
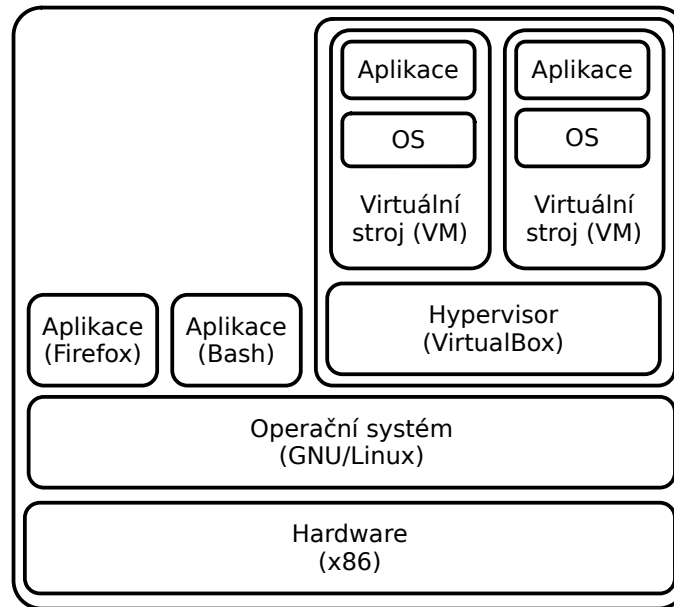

7 – Hardware: úložná zařízení

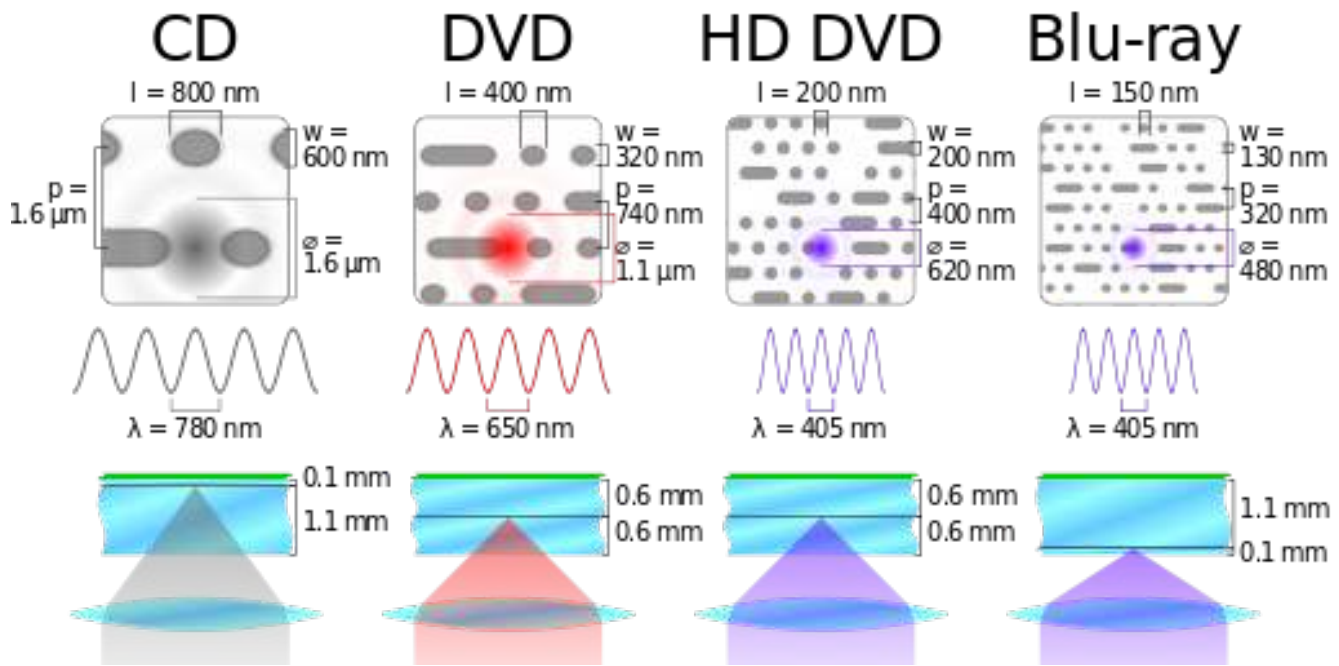

8 – Počítačová grafika a barevné modely

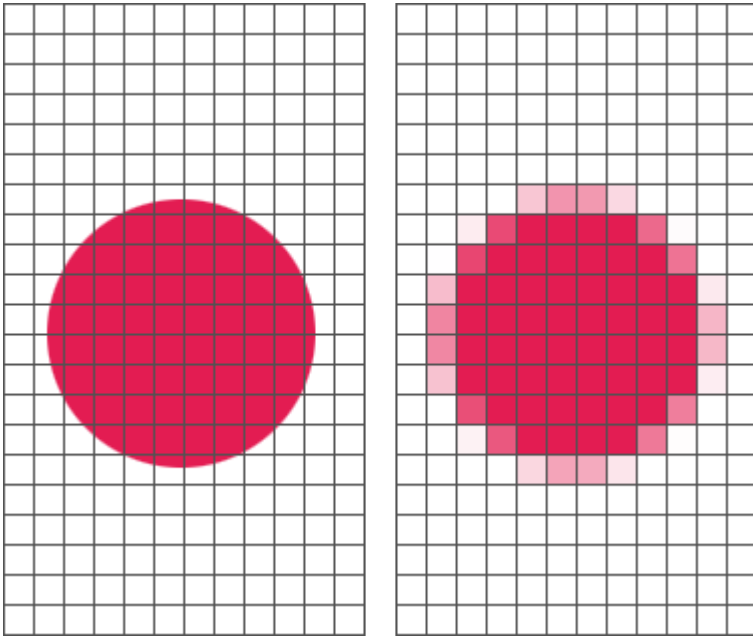

```
<svg xmlns="http://www.w3.org/2000/svg" version="1.1"
      width="180" height="180">
```

```
  <line
    x1="100" y1="60" x2="10" y2="60"
    style="stroke:rgb(255,0,0);" />
```

```
  <line
    x1="10" y1="60" x2="55" y2="10"
    style="stroke:rgb(255,0,0);" />
```

```
  <line
    x1="55" y1="10" x2="100" y2="60"
    style="stroke:rgb(255,0,0);" />
```

```
</svg>
```

8 – Modulární programování

```
FileUtils-2.7.4.lib  
getRecursively(pattern) {  
    ...  
}
```

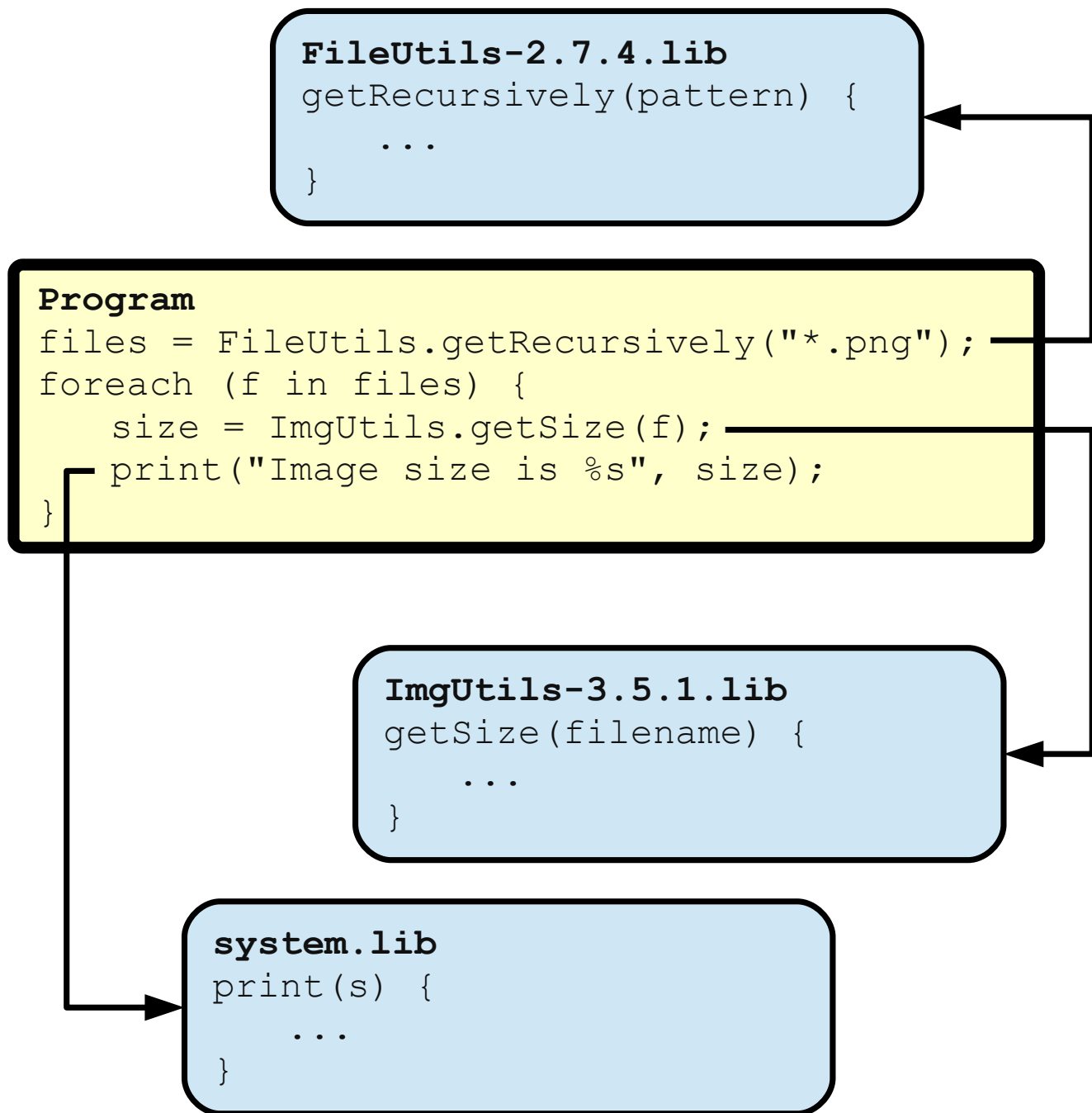

Program

```
files = FileUtils.getRecursively("*.png");  
foreach (f in files) {  
    size = ImgUtils.getSize(f);  
    print("Image size is %s", size);  
}
```

```
ImgUtils-3.5.1.lib  
getSize(filename) {  
    ...  
}
```

```
system.lib  
print(s) {  
    ...  
}
```

9 – Alternativní textové formáty

L^AT_EX

```
\documentclass[a4paper,12pt]{article}

\usepackage[czech]{babel}
\usepackage[utf8x]{inputenc}

\author{Vojtěch Horký}
\title{Maturita}

\begin{document}

\maketitle

\section{Lorem Ipsum}

\Huge{Suspendisse}. Elementum class facilisis morbi penatibus nisi blandit
quis, cum. Ad suscipit vivamus sapien ad mattis senectus. Leo sed imperdiet
ultrices, sapien litora fusce, posuere sapien nisl aenean senectus cubilia
penatibus tempus. Rhoncus ve, consequat iaculis, est parturient donec elit,
amet curabitur mus netus.

Tempus, venenatis porta ad nostra.
Est, nisi pede vel ipsum viverra. Orci.
Fames ut auctor maecenas duis. Eni.
At eu primis fermentum torquent diam sed eni et arcu metus eu.
Class \emph{magna} velit.

\end{document}
```

Markdown

```
% Vojtěch Horký
% Maturita

# Lorem Ipsum
Suspendisse. Elementum class facilisis morbi penatibus nisi blandit
quis, cum. Ad suscipit vivamus sapien ad mattis senectus. Leo sed imperdiet
ultrices, sapien litora fusce, posuere sapien nisl aenean senectus cubilia
penatibus tempus. Rhoncus ve, consequat iaculis, est parturient donec elit,
amet curabitur mus netus.

Tempus, venenatis porta ad [nostra](http://www.example.com).
Est, nisi pede vel ipsum viverra. Orci.
Fames ut auctor maecenas duis. Eni.
At eu primis fermentum torquent diam sed eni et arcu metus eu.
Class *magna* velit.
```

10 – Hardware: CPU a paměť

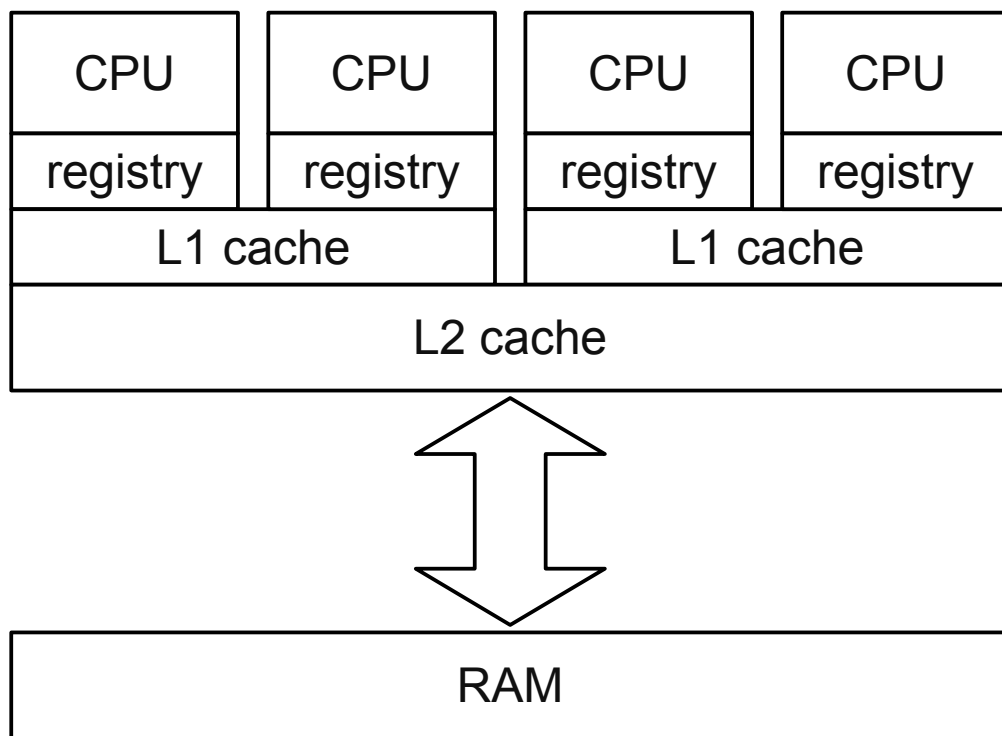

10 – Lokalizace softwaru

GNU gettext

source.c

```
printf(_("My name is %s.\n"), my_name);
```

source.pot

```
/* source.c:36
msgid "My name is %s.\n"
msgstr ""
```

cs.po

```
/* source.c:36
msgid "My name is %s.\n"
msgstr "Jmenuji se %s.\n"
```

ASCII

32	␣	44	,	56	8	68	D	80	P	92	\	104	h	116	t
33	!	45	-	57	9	69	E	81	Q	93]	105	i	117	u
34	"	46	.	58	:	70	F	82	R	94	^	106	j	118	v
35	#	47	/	59	;	71	G	83	S	95	_	107	k	119	w
36	\$	48	0	60	i	72	H	84	T	96	'	108	l	120	x
37	%	49	1	61	=	73	I	85	U	97	a	109	m	121	y
38	&	50	2	62	¿	74	J	86	V	98	b	110	n	122	z
39	'	51	3	63	?	75	K	87	W	99	c	111	o	123	{
40	(52	4	64	@	76	L	88	X	100	d	112	p	124	
41)	53	5	65	A	77	M	89	Y	101	e	113	q	125	}
42	*	54	6	66	B	78	N	90	Z	102	f	114	r	126	
43	+	55	7	67	C	79	O	91	[103	g	115	s		

UTF-8

Bajtu	Code-point (bitů)	Byte 1	Byte 2	Byte 3	Byte 4
1	U+0000 – U+007F (7)	0xxxxxxx			
2	U+0080 – U+07FF (11)	110xxxxx	10xxxxxx		
3	U+0800 – U+FFFF (16)	1110xxxx	10xxxxxx	10xxxxxx	
4	U+10000 – U+10FFFF (21)	11110xxx	10xxxxxx	10xxxxxx	10xxxxxx

Znak	Code-point (bin.)	UTF-8 (bin. & hex.)
\$ U+0024	0010 0100	0:0100100 (24)
€ U+20AC	0010 0000 1010 1100	1110:0010 10:000010 10:101100 (E2 82 AC)

11 – Historie hardware a software

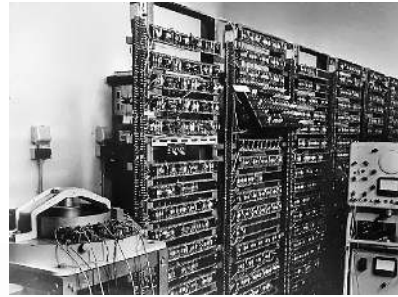
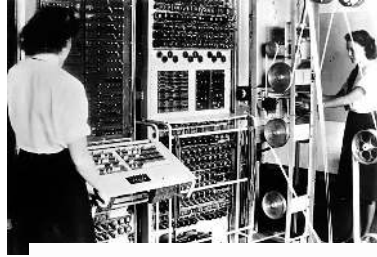
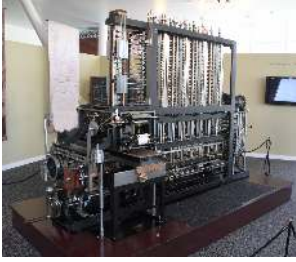

11 – Překladače a řízení překladu

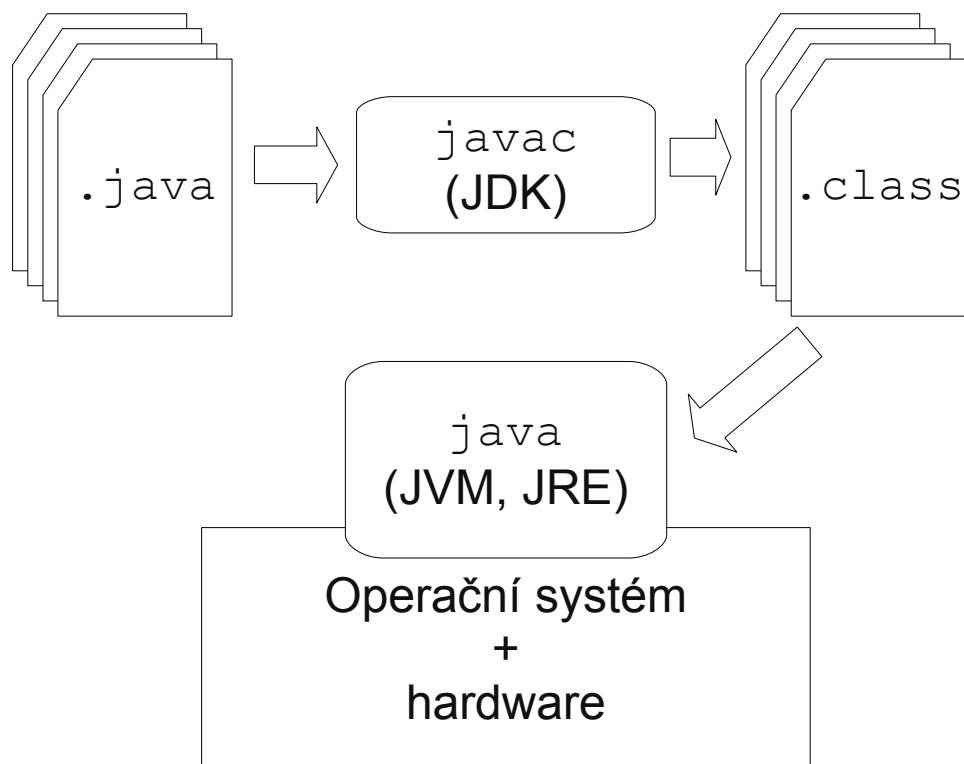

11 – Překladače a řízení překladačů

```
<?xml version="1.0" encoding="UTF-8"?>
<project basedir="." name="Your project" default="main">
  <target name="main" depends="compile"></target>

  <target name="compile">
    <mkdir dir="out/classes" />
    <javac destdir="out/classes" srcdir="src/java" />
  </target>

  <target name="compile-test" depends="compile">
    <mkdir dir="out/test-classes" />
    <javac destdir="out/test-classes">
      <src path="src/test-java" />
      <classpath>
        <pathelement path="out/classes" />
        <pathelement path="lib/junit.jar" />
      </classpath>
      <compilerarg value="-Xlint:all"/>
    </javac>
  </target>

  <target name="test" depends="compile,compile-test">
    <mkdir dir="out/test-results" />
    <junit printsummary="withOutAndErr" haltonfailure="no">
      <classpath>
        <pathelement path="lib/junit.jar"/>
        <pathelement path="out/classes" />
        <pathelement path="out/test-classes" />
      </classpath>
      <formatter type="xml" />
      <batchtest fork="yes" todir="out/test-results">
        <fileset dir="out/test-classes">
          <include name="**/*Test.class"/>
        </fileset>
      </batchtest>
    </junit>
  </target>

  <target name="jar" depends="compile">
    <jar destfile="out/app.jar" basedir="out/classes">
      <manifest>
        <attribute name="Main-Class" value="main.pkg.Name" />
      </manifest>
    </jar>
  </target>

  <target name="clean">
    <delete dir="out" />
  </target>
</project>
```

12 – Verzovací systémy

Index: mainline/ospace/lib/gpt/libgpt.c

```
=====
--- a/mainline/ospace/lib/gpt/libgpt.c
+++ b/mainline/ospace/lib/gpt/libgpt.c
@@ -707,9 +707,5 @@
 }

-/** Generate a new pseudo-random UUID
- *
- * FIXME: This UUID generator is not compliant with RFC 4122.
- *
- */
+/** Generate a new pseudo-random UUID compliant with RFC 4122 */
 void gpt_set_random_uuid(uint8_t *uuid)
 {
@@ -718,4 +714,14 @@
     for (size_t i = 0; i < 16; i++)
         uuid[i] = random();
+
+    /*
+     * Set version (stored in bits 4-7 of seventh byte) to 4 (random
+     * UUID) and bits 6 and 7 of ninth byte to 0 and 1 respectively -
+     * according to RFC 4122, section 4.4.
+     */
     uuid[6] &= 0x0f;
     uuid[6] |= (0x4 << 4);
     uuid[8] &= 0x3f;
     uuid[8] |= (1 << 7);
 }
```

12 – Verzovací systémy

Rev	Message	Date	Authc
1858	add in6addr_any	2013-06...	Mar...
1857	Mostly C style (obey clang suggestions)	2013-06...	Vojt...
1443.1.65	Make mkext2 runnable under Python 3 as well	2013-06...	Vojt...
1443.1.64	C style: type-casting etc.	2013-06...	Vojt...
1443.1.63	C style: uninitialized variables	2013-06...	Vojt...
1443.1.62	C style: do not redefine typedefs	2013-06...	Vojt...
1443.1.61	C style: fix usage of sizeof(void *)	2013-06...	Vojt...
1443.1.60	C style: remove unused variable	2013-06...	Vojt...
1443.1.59	Add -Werror for kernel with Clang	2013-06...	Vojt...
1443.1.58	Honour integer promotion during bitshift	2013-06...	Vojt...
1443.1.57	Clang does not know __attribute__(optimize)	2013-06...	Vojt...
1443.1.56	Merge mainline changes	2013-06...	Vojt...
1856	ata_bd needs to use hw_res (PIO resource c...	2013-06...	Jiri ...
1855	ata_bd should use ddf_msg().	2013-06...	Jiri ...
1854	cstyle (no change in functionality)	2013-06...	Mar...
1853	fix uninitialized variable	2013-06...	Mar...
1852	use optimization level -O3 again	2013-06...	Mar...
1851	routines for IPv6 address parsing and format...	2013-06...	Mar...
1850	Convert ata_bd to DDF.	2013-06...	Jiri ...
1849	Merge from lp: ~jakub/helenos/slip.	2013-06...	Jak...
1815.2.6	Adapt the SLIP server to the new network ad...	2013-06...	Jak...
1815.2.5	Merge mainline changes.	2013-06...	Jak...
1815.2.4	Use two serialized sessions instead of one pa...	2013-05...	Jak...
1815.2.3	Allow ns8250 to be opened multiple-times.	2013-05...	Jak...
1815.2.2	More complete implementation of the SLIP se...	2013-05...	Jak...
1815.2.1	Basic infrastructure for the SLIP server.	2013-05...	Jak...
1848	Encapsulate controller state in ata_bd.	2013-06...	Jiri ...
1847	Rudimentary support for dumping TOC in blk...	2013-06...	Jiri ...
1846	Fix ata_bd crash during read TOC operation.	2013-06...	Jiri ...

Revision: 1443.1.60

revid:vojtechhorky@users.sourceforge.net-20130611141430-g5at5kn4ky6q40nu

Parents: ● [1443.1.59: Add -Werror for kernel with Clang](#)

Children: ● [1443.1.61: C style: fix usage of sizeof\(void *\)](#)

Date: 6/11/13 4:14 PM

Committer: Vojtech Horky

<vojtechhorky@users.sourceforge.net>

Branch: misc

C style: remove unused variable

uspace/app/bdsh/cmds/modules

13 – Kryptografie a ochrana informací

	1	2	3	4	5	6	7	8	9	10	11	12	13	14	15	16	17	18	19	20	21	22	23	24	25	26
1	A	B	C	D	E	F	G	H	I	J	K	L	M	N	O	P	Q	R	S	T	U	V	W	X	Y	Z
2	B	C	D	E	F	G	H	I	J	K	L	M	N	O	P	Q	R	S	T	U	V	W	X	Y	Z	A
3	C	D	E	F	G	H	I	J	K	L	M	N	O	P	Q	R	S	T	U	V	W	X	Y	Z	A	B
4	D	E	F	G	H	I	J	K	L	M	N	O	P	Q	R	S	T	U	V	W	X	Y	Z	A	B	C
5	E	F	G	H	I	J	K	L	M	N	O	P	Q	R	S	T	U	V	W	X	Y	Z	A	B	C	D
6	F	G	H	I	J	K	L	M	N	O	P	Q	R	S	T	U	V	W	X	Y	Z	A	B	C	D	E
7	G	H	I	J	K	L	M	N	O	P	Q	R	S	T	U	V	W	X	Y	Z	A	B	C	D	E	F
8	H	I	J	K	L	M	N	O	P	Q	R	S	T	U	V	W	X	Y	Z	A	B	C	D	E	F	G
9	I	J	K	L	M	N	O	P	Q	R	S	T	U	V	W	X	Y	Z	A	B	C	D	E	F	G	H
10	J	K	L	M	N	O	P	Q	R	S	T	U	V	W	X	Y	Z	A	B	C	D	E	F	G	H	I
11	K	L	M	N	O	P	Q	R	S	T	U	V	W	X	Y	Z	A	B	C	D	E	F	G	H	I	J
12	L	M	N	O	P	Q	R	S	T	U	V	W	X	Y	Z	A	B	C	D	E	F	G	H	I	J	K
13	M	N	O	P	Q	R	S	T	U	V	W	X	Y	Z	A	B	C	D	E	F	G	H	I	J	K	L
14	N	O	P	Q	R	S	T	U	V	W	X	Y	Z	A	B	C	D	E	F	G	H	I	J	K	L	M
15	O	P	Q	R	S	T	U	V	W	X	Y	Z	A	B	C	D	E	F	G	H	I	J	K	L	M	N
16	P	Q	R	S	T	U	V	W	X	Y	Z	A	B	C	D	E	F	G	H	I	J	K	L	M	N	O
17	Q	R	S	T	U	V	W	X	Y	Z	A	B	C	D	E	F	G	H	I	J	K	L	M	N	O	P
18	R	S	T	U	V	W	X	Y	Z	A	B	C	D	E	F	G	H	I	J	K	L	M	N	O	P	Q
19	S	T	U	V	W	X	Y	Z	A	B	C	D	E	F	G	H	I	J	K	L	M	N	O	P	Q	R
20	T	U	V	W	X	Y	Z	A	B	C	D	E	F	G	H	I	J	K	L	M	N	O	P	Q	R	S
21	U	V	W	X	Y	Z	A	B	C	D	E	F	G	H	I	J	K	L	M	N	O	P	Q	R	S	T
22	V	W	X	Y	Z	A	B	C	D	E	F	G	H	I	J	K	L	M	N	O	P	Q	R	S	T	U
23	W	X	Y	Z	A	B	C	D	E	F	G	H	I	J	K	L	M	N	O	P	Q	R	S	T	U	V
24	X	Y	Z	A	B	C	D	E	F	G	H	I	J	K	L	M	N	O	P	Q	R	S	T	U	V	W
25	Y	Z	A	B	C	D	E	F	G	H	I	J	K	L	M	N	O	P	Q	R	S	T	U	V	W	X
26	Z	A	B	C	D	E	F	G	H	I	J	K	L	M	N	O	P	Q	R	S	T	U	V	W	X	Y

13 – Testování softwaru

MathOp.java

```
public class MathOp {
    public int add(int a, int b) {
        return a + b;
    }

    public int sub(int a, int b) {
        return a - b;
    }
}
```

MathOpTest.java

```
import org.junit.*;
import static org.junit.Assert.*;

public class MathOpTest {
    @Test
    public void addingWorks() {
        assertEquals(4, MathOp.add(3, 1));
    }

    @Test
    public void addingZeroWorks() {
        assertEquals(42, MathOp.add(43, 0));
    }

    @Test
    public void subtractionWorks() {
        assertEquals(-4, MathOp.sub(-3, 1));
    }
}
```

14 – Multimedia

```
<dvdauthor dest="dvd">
<vmgm>
  <menus>
    <pgc entry="title">
      <vob file="intro.mpg" />
      <post>jump titleset 1 menu;</post>
    </pgc>
  </menus>
</vmgm>
<titleset>
  <menus>
    <pgc entry="root">
      <button> jump title 1; </button>
      <button> jump title 2; </button>
      <button> jump title 3; </button>
      <button> jump title 4; </button>
      <vob file="menu.mpg" pause="inf" />
    </pgc>
  </menus>
<titles>
  <pgc>
    <vob file="01.mpg"
      chapters="0,5:00,10:00,15:00,20:00,25:00,30:00,35:00"
      pause="3" />
    <post> call menu; </post>
  </pgc>
  <pgc>
    <vob file="02.mpg"
      chapters="0,5:00,10:00,15:00,20:00,25:00,30:00,35:00"
      pause="3" />
    <post> call menu; </post>
  </pgc>
  <pgc>
    <vob file="03.mpg"
      chapters="0,5:00,10:00,15:00,20:00,25:00,30:00,35:00"
      pause="3" />
    <post> call menu; </post>
  </pgc>
  <pgc>
    <vob file="04.mpg"
      chapters="0,5:00,10:00,15:00,20:00,25:00,30:00,35:00"
      pause="3" />
    <post> call menu; </post>
  </pgc>
</titles>
</titleset>
</dvdauthor>
```

14 – Multimedia

Format Container: .avi, .mp4, .mov, .ogg, .flv, .mkv, etc.

Video codec:

H.264,
VC-1,
Theora,
Dirac 2.1,
H.263,
etc.

Audio codec:

AAC,
WMA,
Vorbis,
PCM,
etc.

Captioning,
Video description:

SAMI, SMIL,
Hi-Caption,
CMML, DXFP,
3GPP TS 26.245,
MPSub,
etc.

Metadata:

Author,
Title,
Location,
Date,
Copyright,
License,
etc.

15 – Operační systémy a ovladače

Windows



GNU/Linux

```
$ ssh user@machine
Last login: Wed Apr 25 14:39:12 2018 from 10.10.1.17
[user@machine ~]$ su -
Password:
[root@machine ~]# dnf upgrade
Last metadata expiration check: 0:15:06 ago on Thu 10 May 2018 09:43:17 AM CEST.
Dependencies resolved.
```

```
=====
Package                Arch      Version      Repository    Size
=====
Upgrading:
GeoIP-GeoLite-data     noarch   2018.04-1.fc27  updates      551 k
PackageKit             x86_64   1.1.10-1.fc27  updates      586 k
...
```

```
Transaction Summary:
  Upgrade 161 Packages
```

```
Total download size: 322 M
```

15 – Typografie

AVATAR — AVATAR

ff — ff

abeceda — abeceda

písmeno — **písmeno**

slovo — *slovo*

16 – Správa a zabezpečení počítačových systémů

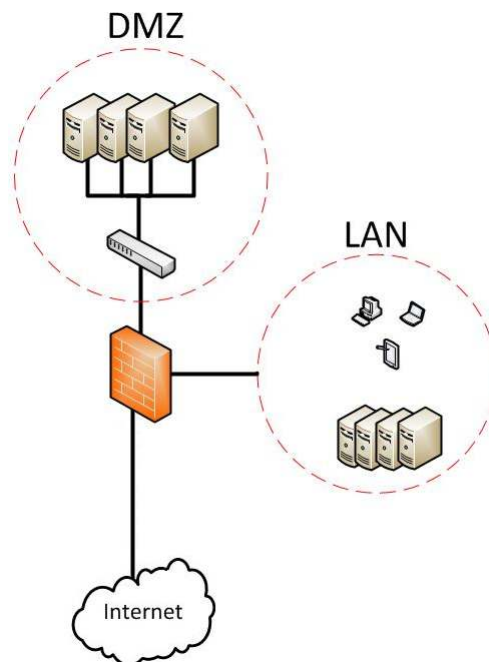
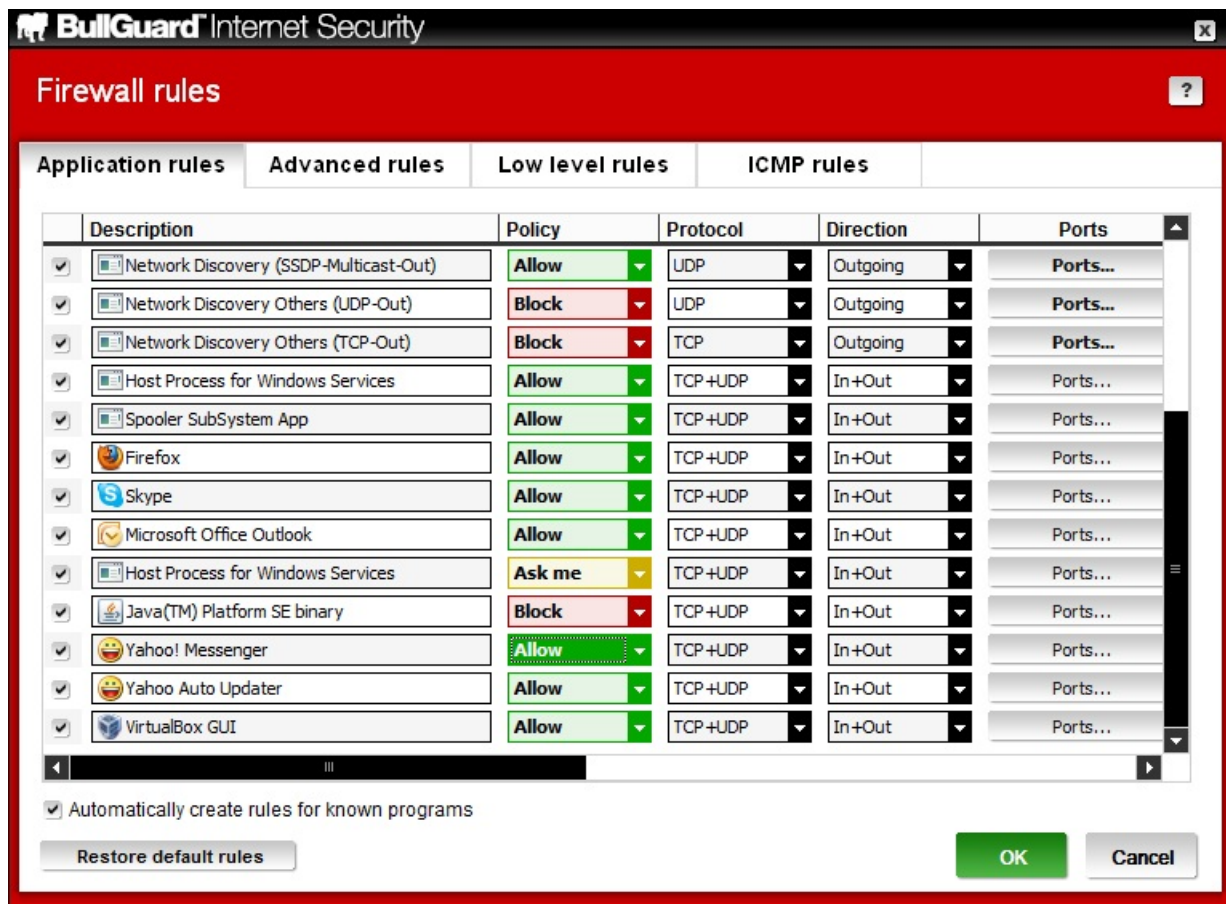

16 – Publikování na webu

Klient

```
GET /index.html HTTP/1.1  
Host: www.example.com
```

Server

```
HTTP/1.1 200 OK  
Date: Mon, 23 May 2005 22:38:34 GMT  
Server: Apache/1.3.3.7 (Unix) (Red-Hat/Linux)  
Last-Modified: Wed, 08 Jan 2003 23:11:55 GMT  
Content-Type: text/html; charset=UTF-8  
Content-Length: 131  
Accept-Ranges: bytes  
Connection: close
```

```
<html>  
<head>  
  <title>An Example Page</title>  
</head>  
<body>  
  Hello World, this is a very simple HTML document.  
</body>  
</html>
```

17 – Dynamické datové struktury

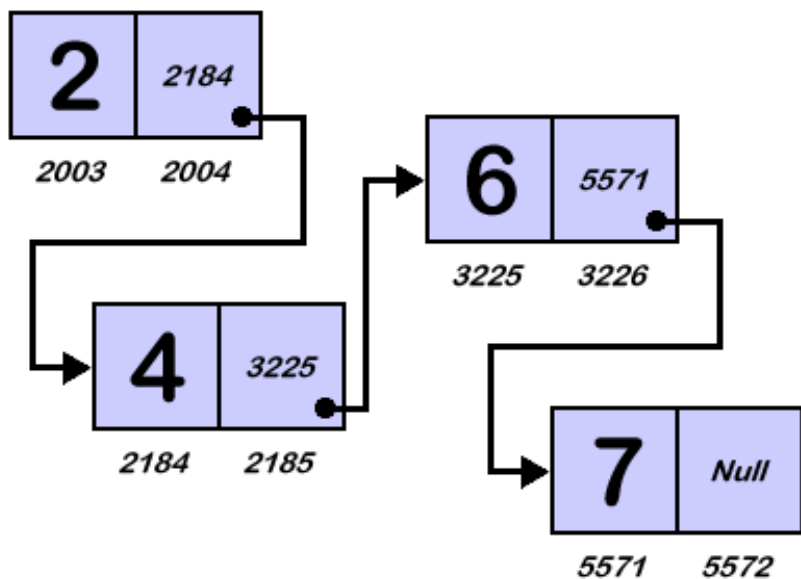
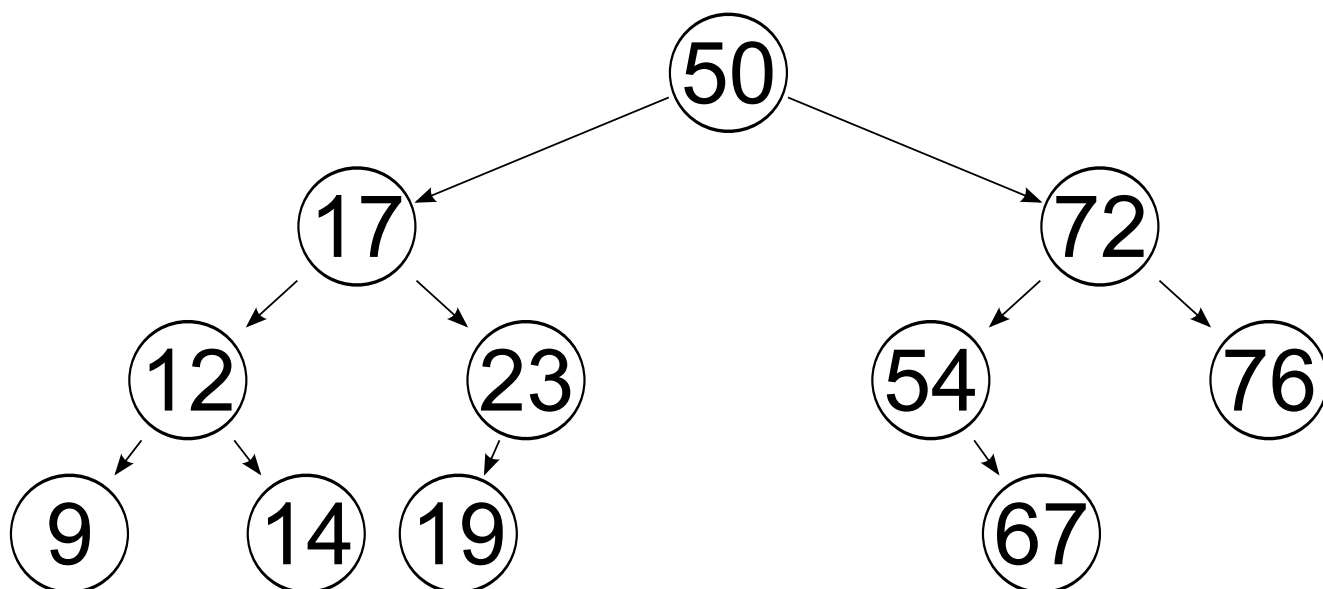

18 – Prohledávání do hloubky a do šířky

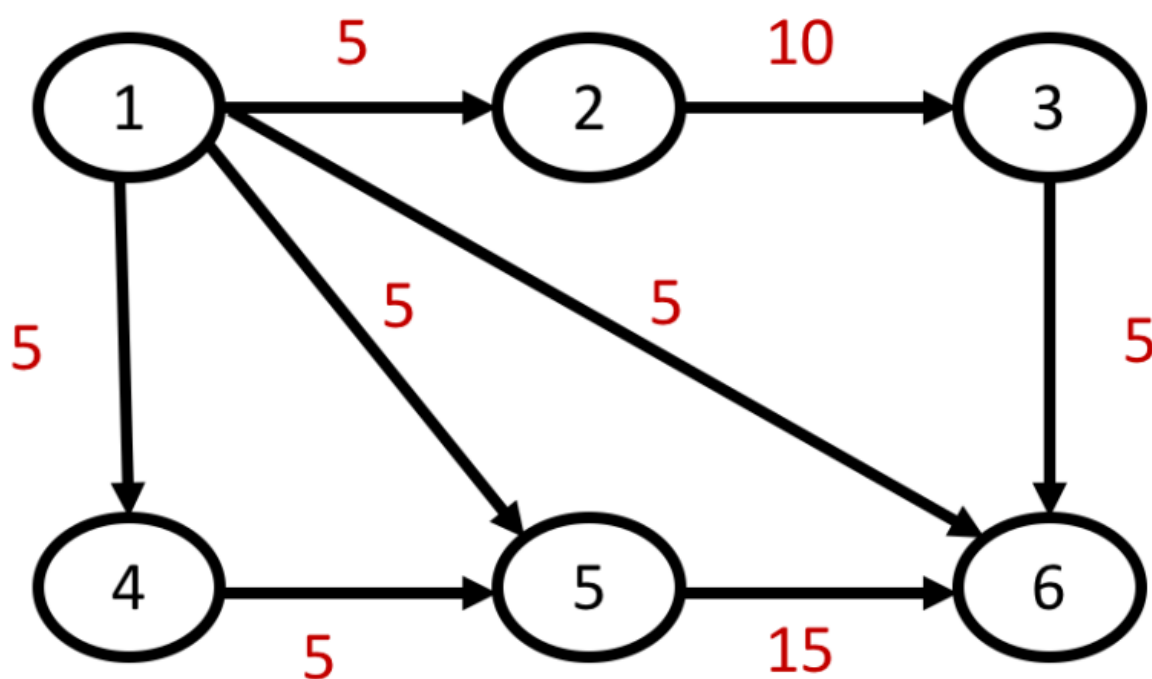
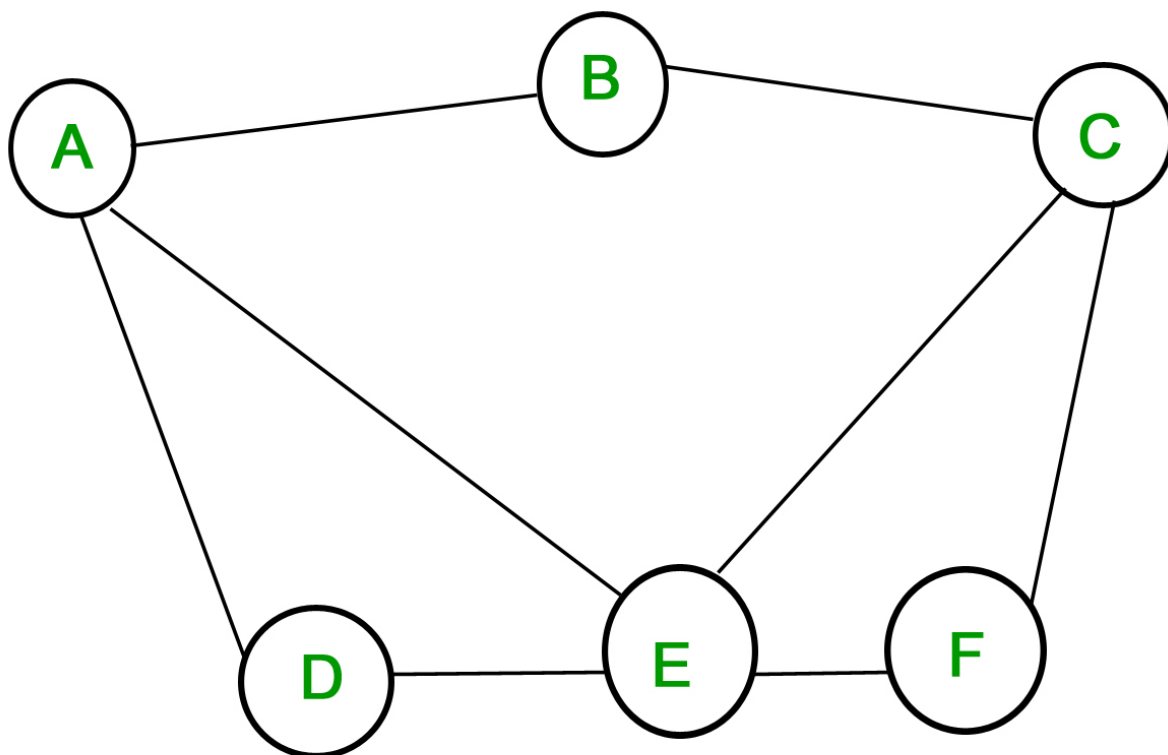

18 – Dávkové úlohy (práce v příkazové řádce)

```
mkdir -p thumb
for i in DSC*.jpg; do
    convert "$i" -resize 800x600 "$( basename "$i" .jpg)".thumb.jpg
done
```

```
#!/bin/bash
```

```
JVM_DIR=/usr/lib/jvm
DEFAULT_NAME=default
DEFAULT_PATH=${JVM_DIR}/${DEFAULT_NAME}
DEFAULT_NAME_JRE=default-runtime
DEFAULT_PATH_JRE=${JVM_DIR}/${DEFAULT_NAME_JRE}
```

```
get_default_java() {
    path=$(readlink -e ${DEFAULT_PATH})
    if [ "x${path}" != "x/dev/null" ]; then
        echo ${path}/${JVM_DIR}\
    else
        echo ""
    fi
}
```

```
get_installed_javas() {
    if [ -d ${JVM_DIR} ]; then
        for dir in $(find ${JVM_DIR} -mindepth 1 -maxdepth 1 -type d | sort); do
            if [ -x ${dir}/bin/java ]; then
                javas+=(${dir}/${JVM_DIR}\)
            else
                if [ -x ${dir}/jre/bin/java ]; then
                    javas+=(${dir}/${JVM_DIR}\)/jre)
                fi
            fi
        done
    fi
    echo ${javas[@]}
}
```

```
# ...
```

```
case $1 in
    'status') do_status;;
    'get') do_get;;
    'set') check_root; check_param_count $# 2; do_set $2;;
    'unset') check_root; do_unset;;
    'fix') check_root; do_fix;;
    'help' | '--help' | '-h' | '') usage;;
    *) echo "$(basename $0): unknown option '$@'"; exit 1;;
esac
```

19 – E-mail a instant messaging

Delivered-To: vojtech.horky@alej.cz
Received: by 10.220.194.1 with SMTP id dw1csp292254vcb;
Wed, 7 May 2014 03:53:25 -0700 (PDT)
X-Received: by 10.182.72.227 with SMTP id g3mr14489014obv.28.1399460005017;
Wed, 07 May 2014 03:53:25 -0700 (PDT)
Return-Path: <XXXXXX@gmail.com>
Received: from mail-ob0-x229.google.com (mail-ob0-x229.google.com)
by mx.google.com with ESMTPS id a7si10520488oex.138.2014.05.07.03.53.24
for <vojtech.horky@alej.cz>
(version=TLSv1 cipher=ECDHE-RSA-RC4-SHA bits=128/128);
Wed, 07 May 2014 03:53:25 -0700 (PDT)
Received-SPF: pass (google.com: domain of domho108@gmail.com designates ...
Authentication-Results: mx.google.com;
spf=pass (google.com: domain of domho108@gmail.com designates ...
dkim=pass header.i=@gmail.com;
dmarc=pass (p=NONE dis=NONE) header.from=gmail.com
Received: by mail-ob0-f169.google.com with SMTP id vb8so967590obc.0
for <vojtech.horky@alej.cz>; Wed, 07 May 2014 03:53:24 -0700 (PDT)
MIME-Version: 1.0
Received: by 10.182.135.47 with HTTP; Wed, 7 May 2014 03:53:04 -0700 (PDT)
From: YYYYY ZZZZZ <XXX@gmail.com>
Date: Wed, 7 May 2014 12:53:04 +0200
Message-ID: <CA0e0qwszP-v2SRSVKS1SG4D-92Ukxf+AVGbXfjaaapJ6srs0cw@mail.gmail.com>
Subject: QQQQQQQQQQQQ
To: vojtech.horky@alej.cz
Content-Type: multipart/mixed; boundary=001a1134aa0e73b84704f8cd2ca0

--001a1134aa0e73b84704f8cd2ca0
Content-Type: text/plain; charset=UTF-8
Content-Transfer-Encoding: quoted-printable

Dobr=C3=BD den,

bla blah

--001a1134aa0e73b84704f8cd2ca0
Content-Type: application/zip; name="file.zip"
Content-Disposition: attachment; filename="file.zip"
Content-Transfer-Encoding: base64
X-Attachment-Id: f_huwj33e60

UESDBAoAAAAAAKtpp0QAAAAAAAAAAAAAAAAAGAAAASG9kYW4vUESDBBQAAAAIAGhppORRBBZqqQIA
....
AQAAEAAAAAAAAAAAAACAAAABOEAAAASG9kYW4vdGFwZXR5LnR4dFBLAQIUABQAAAAIAHhnp0QrI30V
YgAAAPYAAAAARAAAAAAAAAAAAAIAAAAKYRAABiB2Rhbi92eXR2b3IuYmF0dFBLBQYAAAAADAAMA0IC
AAA3EgAAAAA=
--001a1134aa0e73b84704f8cd2ca0--

20 – Licencování softwaru

Copyright (c) 2016 John Doe

All rights reserved.

Redistribution and use in source and binary forms, with or without modification, are permitted provided that the following conditions are met:

- Redistributions of source code must retain the above copyright notice, this list of conditions and the following disclaimer.
- Redistributions in binary form must reproduce the above copyright notice, this list of conditions and the following disclaimer in the documentation and/or other materials provided with the distribution.
- The name of the author may not be used to endorse or promote products derived from this software without specific prior written permission.

THIS SOFTWARE IS PROVIDED BY THE AUTHOR ‘‘AS IS’’ AND ANY EXPRESS OR IMPLIED WARRANTIES, INCLUDING, BUT NOT LIMITED TO, THE IMPLIED WARRANTIES OF MERCHANTABILITY AND FITNESS FOR A PARTICULAR PURPOSE ARE DISCLAIMED. IN NO EVENT SHALL THE AUTHOR BE LIABLE FOR ANY DIRECT, INDIRECT, INCIDENTAL, SPECIAL, EXEMPLARY, OR CONSEQUENTIAL DAMAGES (INCLUDING, BUT NOT LIMITED TO, PROCUREMENT OF SUBSTITUTE GOODS OR SERVICES; LOSS OF USE, DATA, OR PROFITS; OR BUSINESS INTERRUPTION) HOWEVER CAUSED AND ON ANY THEORY OF LIABILITY, WHETHER IN CONTRACT, STRICT LIABILITY, OR TORT (INCLUDING NEGLIGENCE OR OTHERWISE) ARISING IN ANY WAY OUT OF THE USE OF THIS SOFTWARE, EVEN IF ADVISED OF THE POSSIBILITY OF SUCH DAMAGE.

20 – Specializované programovací jazyky

Vstup

11,12
15,18
21,35

AWK

```
BEGIN {  
    # field-separator by byl jinak tabulator  
    FS=","  
}  
  
{  
    print $1 + $2  
}
```

Java

```
public class Secti {  
    public static void main(String[] args) {  
        java.util.Scanner sc = new java.util.Scanner(System.in);  
        while (sc.hasNextLine()) {  
            String line = sc.nextLine();  
            String[] casti = line.split(",");  
  
            int a = Integer.parseInt(casti[0]);  
            int b = Integer.parseInt(casti[1]);  
            System.out.println(a + b);  
        }  
        sc.close();  
    }  
}
```